

CS/CTS

USER GUIDE

JUICE
ATTITUDE

EVOLUTION

MILEAGE MAX

INSIGHT



CTS

COLOR TOUCH SCREEN



CS

COLOR SCREEN

EDGE
PRODUCTS

TABLE OF CONTENTS

INTRODUCTION

PARTS DESCRIPTION

INSTALLATION

OPERATING INSTRUCTIONS

INTERNET UPDATES

APPENDIX

INTRODUCTION..... 4

DISCLAIMER OF LIABILITY..... 4

LIMITATION OF WARRANTY 5

PARTS DESCRIPTION 10

PARTS INCLUDED..... 10

PARTS DESCRIPTION 11

INSTALLATION INSTRUCTIONS 13

INSTALLATION 14

DEVICE POWER UP 19

CTS/CS DEVICE DESCRIPTIONS 20

CTS LAYOUT 21

CS LAYOUT..... 21

OPERATING INSTRUCTIONS 22

NAVIGATING THE MENU SYSTEM 22

MAIN MENU..... 22

VIEW CAMERA..... 23

CS/CTS ALERTS 24

SHOW ALERTS 25

PROGRAMMING..... 26

POWER LEVELS..... 27

CUSTOM OPTIONS 28

DIAGNOSTICS..... 30

TROUBLE CODES..... 31

MANUAL DPF REGENERATION 33

PERFORMANCE TESTS..... 34

INJECTOR BALANCE RATES 36

OPTIONS..... 38

ALERT SETTINGS..... 38

SOUND DURATION..... 40

SCREEN LAYOUT 40

BACKLIGHT AUTO DIM..... 41

MENU TIME-OUT..... 42

TIRE SIZE..... 42

FACTORY RESET..... 44

CAMERA DELAY 45

HELP MENU 46

PRODUCT INFO..... 46

VEHICLE INFO 47

CONTACT INFO 48

<i>TECH SUPPORT TOOLS</i>	49
<i>FUSION UPDATE SOFTWARE</i>	50
POSSIBLE PROGRAMMING ERRORS	52
<i>UPDATE REQUIRED</i>	52
<i>NON-STOCK CONDITION</i>	52
ACCESSORIES	53
<i>EDGE ACCESSORIES SYSTEM (EAS)</i>	53
<i>OEM EGT LOCATIONS</i>	54
APPENDIX	58
<i>EDGE BACKUP CAMERA</i>	58
<i>EDGE MOUNTING SOLUTIONS</i>	59
<i>TROUBLE SHOOTING/TIPS</i>	60
COMMONLY USED ACRONYMS	61

For additional questions not found in the user guide call:

Edge Products Technical Support

(888) 360-EDGE (3343)

8:00 am - 5:00 pm MST

INTRODUCTION

PARTS DESCRIPTION

INSTALLATION

OPERATING INSTRUCTIONS

INTERNET UPDATES

APPENDIX

DISCLAIMER OF LIABILITY

THIS IS A HIGH PERFORMANCE PRODUCT. USE AT YOUR OWN RISK.

Do not use this product until you have carefully read the following agreement.

This sets forth the terms and conditions for the use of this product. THE INSTALLATION OF THIS PRODUCT INDICATES THAT THE BUYER HAS READ AND UNDERSTANDS THIS AGREEMENT AND ACCEPTS ITS TERMS AND CONDITIONS.

DISCLAIMER OF LIABILITY

Edge Products, LLC, MSDP Inc., and their successors, distributors, jobbers, and dealers (hereafter SELLER) shall in no way be responsible for damage resulting from incorrect use of this product. The BUYER/USER assumes all responsibility for any damage resulting from the use or misuse of this product. THE BUYER HEREBY WAIVES ALL LIABILITY CLAIMS.

The BUYER acknowledges that he/she is not relying on the SELLER's skill or judgment to select or furnish goods suitable for any particular purpose and that there are no liabilities which extend beyond the description on the face hereof and the BUYER hereby waives all remedies or liabilities, expressed or implied, arising by law or otherwise, (including without any obligations of the SELLER with respect to fitness, merchantability and consequential damages) or whether or not occasioned by the SELLER's negligence.

The SELLER disclaims any warranty and expressly disclaims any liability for personal injury or damages. The BUYER acknowledges and agrees that the disclaimer of any liability for personal injury is a material term for this agreement and the BUYER agrees to indemnify the SELLER and to hold the SELLER harmless from any claim related to the item of the equipment purchased. Under no circumstances will the SELLER be liable for any damages or expenses by reason of use or sale of any such equipment.

The SELLER assumes no liability regarding the improper installation or misapplication of its products.

It is the installer's responsibility to check for proper installation and if in doubt, contact the manufacturer.

LIMITATION OF WARRANTY

LIMITATION OF WARRANTY

Edge Products, LLC, MSDP Inc., (hereafter “SELLER”) gives Limited Warranty as to description, quality, merchantability, fitness for any product’s purpose, productiveness, or any other matter of SELLER’s product sold herewith. The SELLER shall be in no way responsible for the product’s open use and service and the BUYER hereby waives all rights other than those expressly written herein. This Warranty shall not be extended or varied except by a written instrument signed by SELLER and BUYER.

The Warranty is Limited to one (1) year from the date of sale and limited solely to the parts contained within the product’s kit. All products that are in question of Warranty must be returned shipping prepaid to the SELLER and must be accompanied by a dated proof of purchase receipt. All Warranty claims are subject to approval by Edge Products Inc.

Under no circumstances shall the SELLER be liable for any labor charged or travel time incurred in diagnosis for defects, removal, or reinstallation of this product, or any other contingent expenses.

If the BUYER sends back a failed unit that is out of warranty and chooses to buy a refurbished unit, the refurbished unit will only carry a 90 day warranty. If the BUYER purchases a new unit at a predetermined discounted rate, it will have the standard 1 year warranty.

Under no circumstances will the SELLER be liable for any damage or expenses insured by reason of the use or sale of any such equipment.

IN THE EVENT THAT THE BUYER DOES NOT AGREE WITH THIS AGREEMENT, THE BUYER MAY PROMPTLY RETURN THIS PRODUCT, IN A NEW AND UNUSED CONDITION, WITH A DATED PROOF OF PURCHASE, TO THE PLACE OF PURCHASE WITHIN THIRTY (30) DAYS FROM DATE OF PURCHASE FOR A FULL REFUND.

Note: *This warranty is void for any new products purchased through auction websites. Warranty is valid only for new products purchased through Authorized Dealers (proof of purchase required for all warranty claims).*

IMPORTANT INFORMATION ABOUT YOUR VEHICLE'S WARRANTY — PLEASE READ!

Many of our customers ask, “Will your product void my vehicle’s manufacturer’s warranty?” While the answer is straightforward from a legal standpoint, it’s important to educate our customers (and all aftermarket consumers) on some industry realities and offer some common sense precautions to minimize your risk. Edge is committed to providing quality products that are safe to use. Our products do not cause damage to a vehicle when used as intended. *Please keep in mind that towing in anything higher than the towing level and hard driving in race or extreme performance levels is not recommended.*

Consumers of aftermarket products are protected by the Federal Magnusson-Moss Warranty Act. The Act states that if something breaks on your vehicle and you take it in for warranty repair, the dealer must honor your warranty unless whatever modifications you have added to your vehicle actually caused the problem in question.

However, the reality is that many dealerships have been known to void warranties on vehicles that use aftermarket products as a matter of policy. This applies in particular to those aftermarket products that produce horsepower, such as performance enhancement “chips,” modified intake manifolds, or aftermarket exhaust systems, regardless of product brand.

You have strong legal protection as a consumer in regard to your vehicle’s warranty. However, Edge strongly recommends you always disconnect and remove your module/programmer and monitor when you take your vehicle to a dealer for warranty work. In addition, leaving the product connected may affect dealer diagnostic analysis and CAN tool functions. Edge makes every effort to produce product that can be easily removed.

Note: *Even if you disconnect your unit, your dealer may detect the use of any programmer—even if the unit has been removed.*

Thank you for purchasing the CS and CTS product or device. The CS and CTS products have been developed and produced from the highest quality materials available to ensure the best performance for years to come. If you have any concerns or questions, please contact us.

PLEASE take the time to register your product on line at [edgeproducts.com](http://www.edgeproducts.com). Follow the instructions at link: http://www.edgeproducts.com/product_registration.php

Why register? Benefits of product registration:

- **Your Safety** - registering your product allows us to know exactly which product you have and provide important product updates to you that improve the quality and/or safety of the product
- **Enhanced Features** - almost all Edge products are easily updated via the internet. We are constantly adding new features and improvements to our product that we know you will want to enjoy
- **Confirmation of Ownership** - provides a record in case of product loss, theft, or required warranty work. When you call us for support our team will already have much of the information they need to help you
- **Improved Product Development** - helps us better understand you (our customers) and design products that meet your needs
- **Special Offers** - allows us to inform you about special offers on accessories and/or new products that fit your vehicle and enhance your driving experience
- **Extended Warranty Plan Opportunity** - within the first 90 days of ownership, Edge offers the option to buy a 1-year warranty extension to all customers who register their product!

CAUTION: RETURN YOUR VEHICLE TO STOCK BEFORE TAKING IT TO A SERVICE CENTER

If you take your vehicle to a service center they may, by your request or otherwise, update your vehicle's calibrations. All Edge modules and programmers are built to operate with OEM calibrations. If this happens and your vehicle has not been returned to stock your device will no longer be capable of programming your vehicle. Therefore it is important that you return your vehicle to stock before taking it in for service. Edge updates its active products (i.e. those currently being manufactured) to work effectively with updated OEM calibrations. However, this process can take some time as Edge is not always made aware of calibration changes made by the OEM. In the case of discontinued products, Edge cannot ensure that your unit will work effectively if you take your vehicle to a dealership and you are given, by your request or otherwise, a new calibration.

INTRODUCING THE CS AND CTS MODELS

From the pioneers in display-based technology and engine performance management, comes the CS (Color Screen) and CTS (Color Touch Screen) for popular domestic late model trucks and SUVs. Edge has reinvented four of its most popular lines – the Insight*, Mileage Max*, Evolution, and Juice/Attitude* – with an all-new look and cool new features.

*COMING SOON - CHECK

WWW.EDGEPRODUCTS.COM FOR INFORMATION

THE BREAKDOWN

Four product lines, two screen options. It's just that simple. Edge has taken its best-known products – the Insight, Mileage Max, Evolution, and Juice/Attitude – and given them a fresh look, improved features and benefits, and pricing that will make the competition obsolete. Consumers can pick the product that suits their needs and then choose the screen option that best fits them.

THE CS (COLOR SCREEN)

The CS – an acronym for Color Screen – has a familiar feel of Edge's popular legacy Attitude and Evolution. This new full-color digital display features a ruggedized case, user-friendly buttons, an easy-to-navigate menu, and a light sensitivity sensor that automatically adjusts the brightness for improved night viewing.



THE CTS (COLOR TOUCH SCREEN)

The CTS – an acronym for Color Touch Screen – is the pinnacle of what made Edge popular: Innovation. The CTS model features a full-color, button-free, touch-screen digital display; an easy-to-navigate menu; a light sensitivity sensor that automatically adjusts the brightness for improved viewing; and a video-in jack that supports most off-the-shelf backup cameras or DVD players with an RCA jack.



INTRODUCTION

PARTS DESCRIPTION

INSTALLATION

OPERATING INSTRUCTIONS

INTERNET UPDATES

APPENDIX



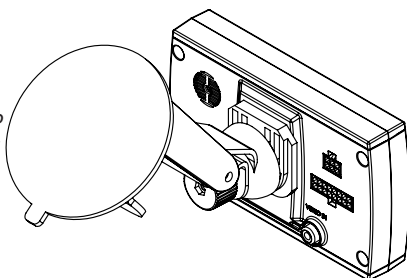
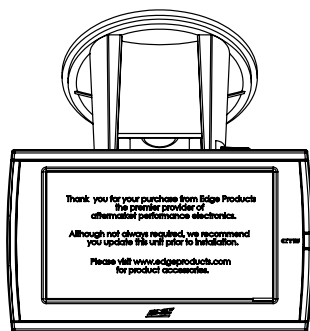

MOUNTING OPTIONS & ACCESSORIES

Both CS and CTS devices come with a standard windshield mount from Arkon Resources Inc., the leader in device-mounting solutions. The CS and CTS devices have a standard two-tab system built in so they can accept an array of different Arkon mounts. Additionally, the CS unit will fit into any of Edge's popular custom dash pods or pillar mounts. The CS and CTS will accept various sensors (e.g., EGT sensor, wide band O2 sensor, etc.), so customers can customize their devices with accessories to fit their needs.

***NOTE:** THE CTS CAN ALSO BE USED WITH EDGE'S CUSTOM DASH PODS BY USING AN ADAPTER KIT.

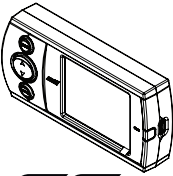
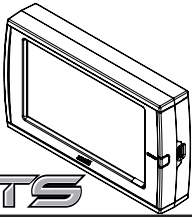
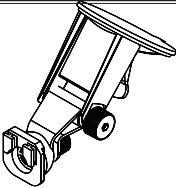
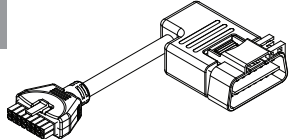
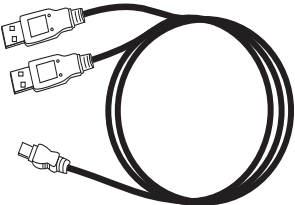

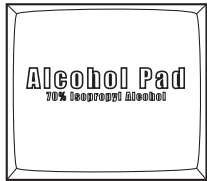
PARTS INCLUDED

<i>Supplied Items</i>	<i>Suggested Tools</i>
<ol style="list-style-type: none"> 1. CS or CTS Device 2. Arkon Windshield Mount 3. OBDII Cable 4. Mini USB Cable 5. CD (contains manual/update software) 6. Alcohol Wipe 7. Zip Tie Packet 	<ul style="list-style-type: none"> • Flat head screwdriver • Cutting Pliers
<p>1</p> <div style="display: flex; justify-content: space-around; align-items: center;"> <div style="text-align: center;">  <p>CS</p> </div> <div style="text-align: center;">  <p>CTS</p> </div> </div>	
<p>2</p> 	<p>3</p> 
<p>4</p> 	<p>5</p> 
<p>6</p> 	<p>7</p> 

PARTS DESCRIPTION

The Parts Description section of this manual describes each of the parts included in your CS/CTS kit both physically as well as functionally.

CTS Device

The CTS device provides you with an interface to change the performance programming on your vehicle as well as gives you a multi-color touch screen display which allows you to monitor multiple vehicle parameters in real time. It is equipped with a large touch screen, a USB port (for PC communication and electronic updates), a 16-pin connector (for main vehicle communication), a video-in jack, and a six-pin accessories connector which allows you to further extend the capabilities of the device (see the accessories page in the back of the manual).

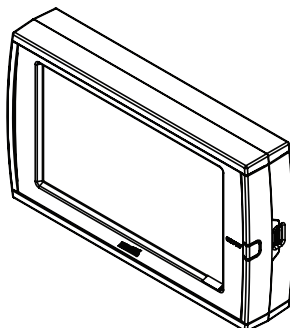

CS Device

The CS device provides you with an interface to change the performance programming on your vehicle as well as gives you a multi-color screen display which allows you to monitor multiple vehicle parameters in real time. It is equipped with a full color screen, a Menu button, Up and Down Arrow button, an Enter button, USB port (for PC communication and electronic updates), a 16-pin connector (for main vehicle communication), and a six-pin accessory connector.

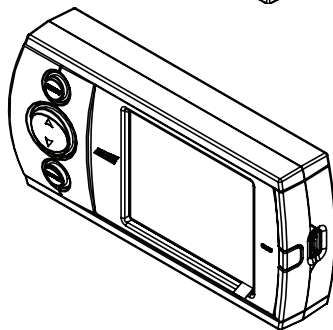

CS/CTS Windshield Mount

The windshield mount supplied with your CS/CTS kit is designed to give you flexibility in mounting your device anywhere you'd like on your windshield. It is equipped with a locking suction cup, a vertically adjustable arm, and a 180° pivot head which allows you to fine tune the viewing angle to your preference.

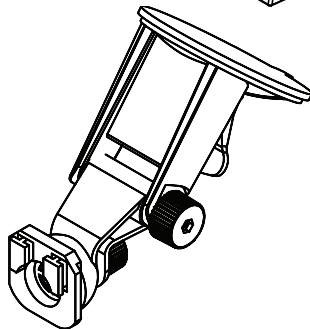

CS/CTS OBDII Connector

The OBDII connector/cable has two plugs, a smaller male 16-pin plug that connects to the back of your device, and a larger rectangle style 16-pin male connector which connects to the OBDII port located under the driver's side dashboard. The purpose of this connector is to provide a communication link between your vehicle and your device as well as provide a power and ground source.

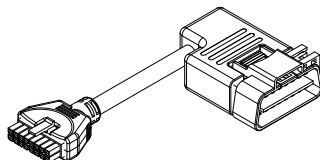

Mini USB Cable

The USB cable is used to connect your device to your PC in order to perform firmware and calibration updates using Edge Products Fusion software. It is recommended you plug both USB connectors into the computer, and complete the Fusion software installation before connecting the device.

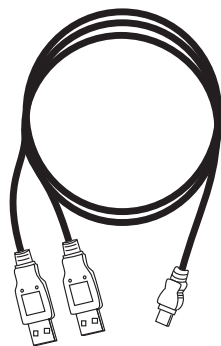

CS/CTS Compact Disc

The CS/CTS compact disc contains the Fusion update software, and PDF files for the Installation manual as well as the quick install guide.



Alcohol Pad

The alcohol pad is supplied for cleaning the windshield prior to mounting the suction cup equipped Arkon mount.

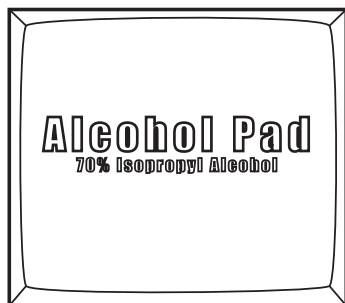

Zip Ties

The zip tie packet contains zip ties to help you secure the OBDII cable out of the way under the dash.



INSTALLATION INSTRUCTIONS

Step 1: Locating the OBDII Port

The OBDII port is a 16-pin connector like the illustration below.

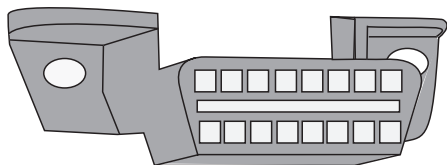

OBDII PORT

The OBDII port is located under the dash below the steering wheel.

The OBDII port is placed in different locations under the dash for different applications; refer to the OBDII port location drawing (left) to help you locate your OBDII port.

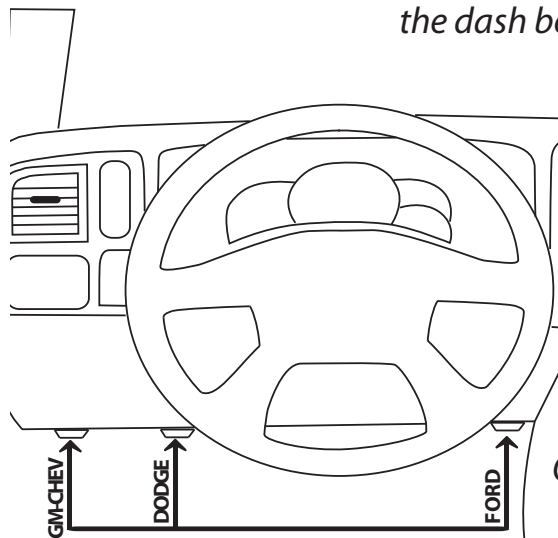

OBDII LOCATIONS

**07 + FORD SUPERDUTY
OBDII PORTS ARE LOCATED ON THE LEFT SIDE OF THE WHEEL INSTEAD OF THE RIGHT*

** 94-97 FORD POWERSTROKES ARE LOCATED ON THE PASSENGER SIDE BELOW AND TO THE LEFT OF THE GLOVE BOX.*

Step 2: Connecting/Routing the OBDII Cable

INTRODUCTION

PARTS DESCRIPTION

INSTALLATION

OPERATING INSTRUCTIONS

INTERNET UPDATES

APPENDIX

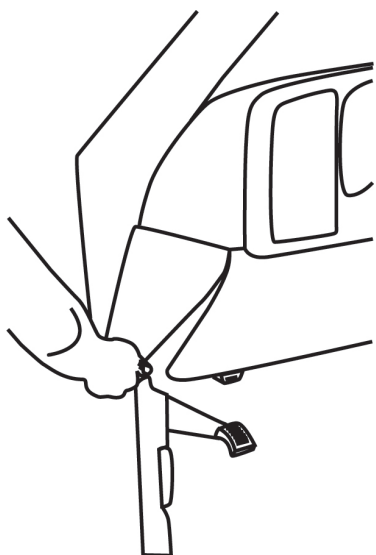

Remove the panel on the side of the dashboard to provide access to route the OBDII cable from the OBDII port up to the top of the dash.

**ON SOME VEHICLES YOU MAY ALSO NEED TO REMOVE THE PANEL DIRECTLY UNDER THE STEERING WHEEL*

Once you've removed the necessary panels, connect the OBDII cable to the OBDII port, and route the cable under the dash, out the side panel, up between the door seal trim and the edge of the dash. Tuck the cable back as far as you can as you route it up to the dash.

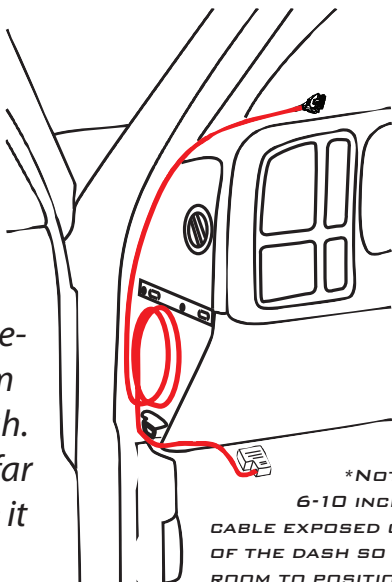

**NOTE: LEAVE 6-10 INCHES OF CABLE EXPOSED ON TOP OF THE DASH SO YOU HAVE ROOM TO POSITION THE CONTROL UNIT.*

Step 3: Position the Control Unit

Position the device and the mount on the windshield in the desired location.

Pay attention to where the suction cup will mount on the windshield.

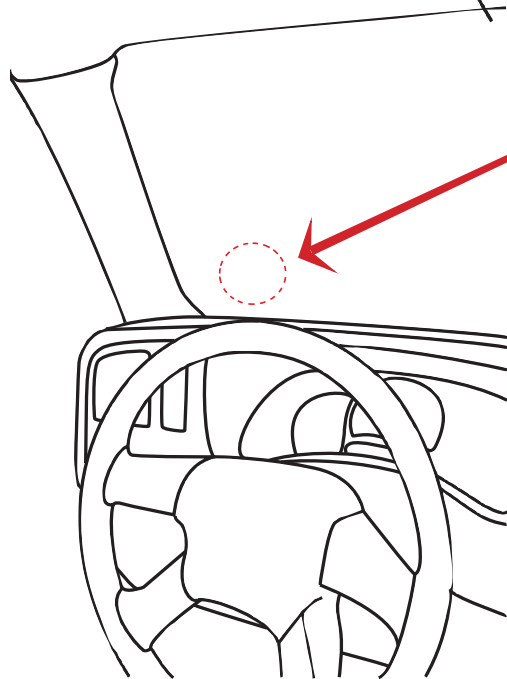
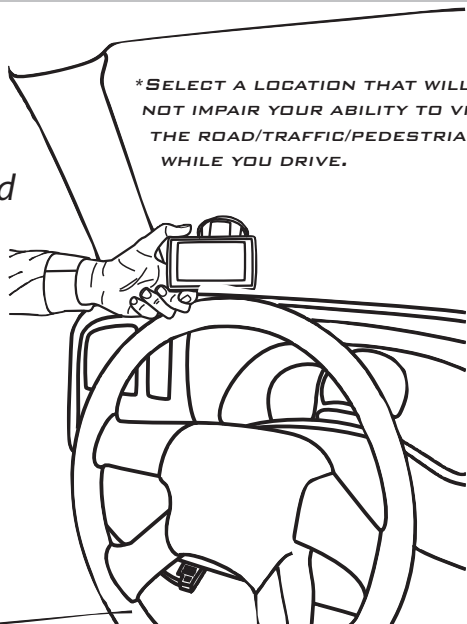

Once you've identified the suction cup position on the windshield, use the supplied alcohol wipe to thoroughly clean the area. After you've wiped the area clean, let it dry for 2-3 minutes.

Step 4: Connect the Mount and OBDII Cable

Before you attach the suction cup portion of the mount to the window attach it to the device. Insert the tabs on the mount into the slots on the back of the device and slide up (CTS) or to the side (CS) until it stops.

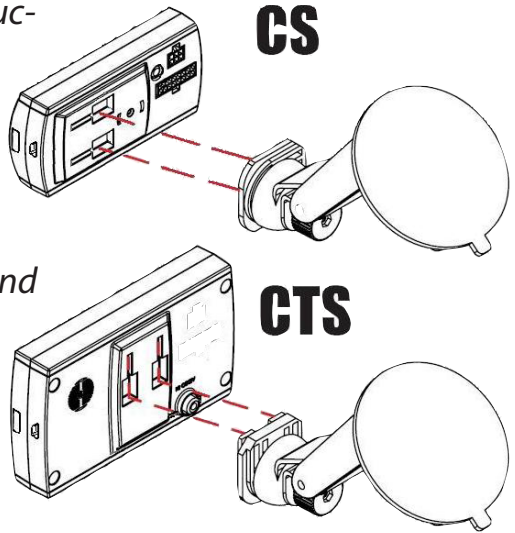

*THE MOUNTING TABS ARE A TIGHT FIT BY DESIGN IN ORDER TO MAINTAIN A SOLID CONNECTION.

Next, insert the connector on the end of the OBDII cable into the 16-pin connector on the back of the device (this is easier if done prior to mounting the device on the window). The connector only fits one way so be sure that the locking tab is on the bottom.

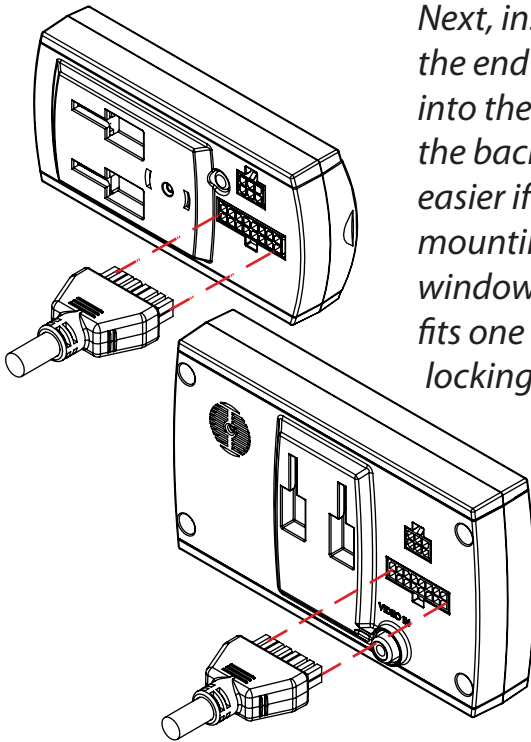

INTRODUCTION

PARTS DESCRIPTION

INSTALLATION

OPERATING INSTRUCTIONS

INTERNET UPDATES

APPENDIX

Step 5: Position and Lock the Unit on the Windshield

Once the alcohol has dried you're ready to attach the mount to the windshield.

You'll notice that the mount has a locking tab. This tab creates the suction that will lock the mount to the windshield. Make sure the lock is in the "Unlocked" position. Position the mount where you've cleaned the windshield, press firmly, and push the tab to the "Locked" position.

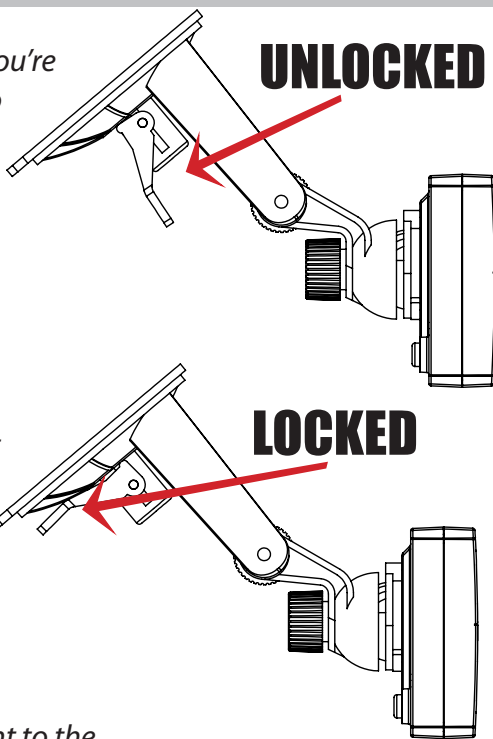

Once you've locked the mount to the windshield, use the adjustment knobs to fine tune the viewing angle and height of the CTS/CS device.

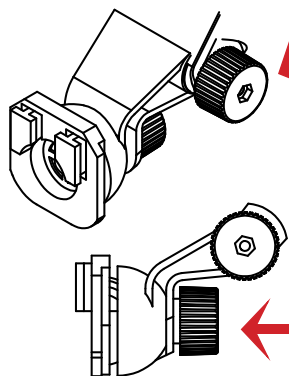

VERTICAL ADJ. KNOB

This knob will allow you to adjust the viewing angle and height of the control unit up or down.

VARIABLE ANGLE ADJ KNOB

This knob will allow you to adjust the viewing angle of the control unit in both horizontal and vertical fashions. Use it to fine tune your viewing angle.

Step 6: Verify Position and Viewing Placement

After you've locked the mount and the CS/CTS device is in place on your windshield, sit back in your drivers seat and make sure the viewing angle is as desired. Check to make sure the device doesn't create a blind spot that may impair your view of the road/traffic/pedestrians from the drivers seat.

*NOTE: SOME STATES PROHIBIT MOUNTING DEVICES THAT MAY OBSTRUCT YOUR VIEW. PLEASE CHECK LOCAL AND STATE LAWS TO ENSURE COMPLIANCE.
FOR ALTERNATE MOUNTING OPTIONS VISIT WWW.EDGEPRODUCTS.COM OR WWW.ARKON.COM

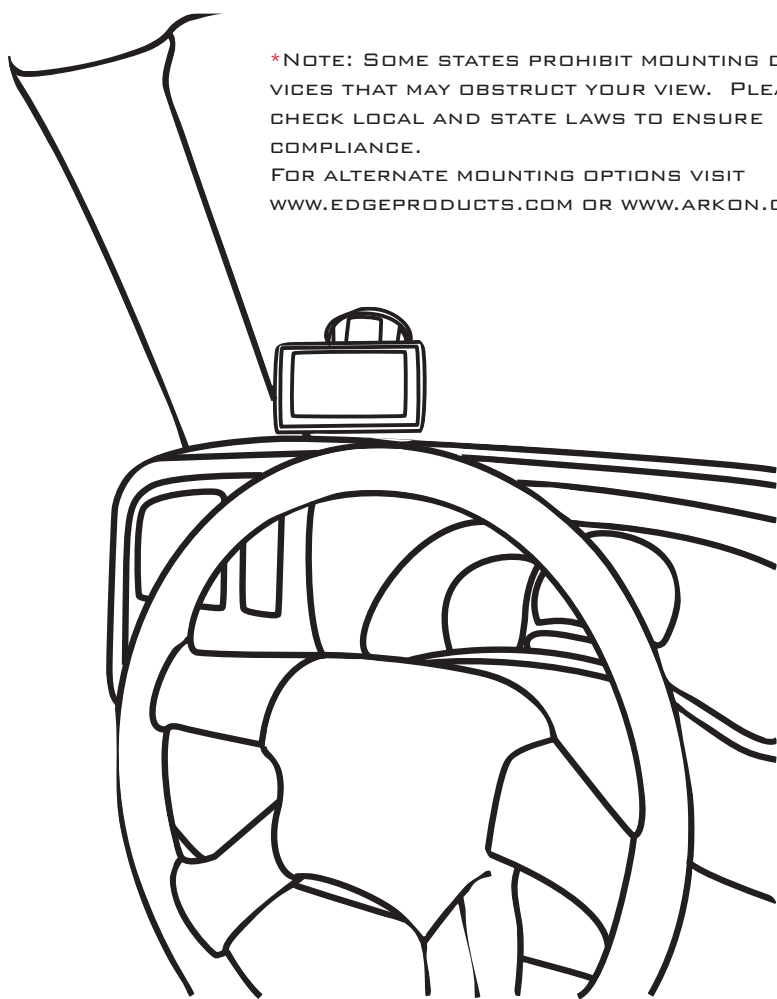

Step 7: Remove Cable Slack/Replace Panels

After positioning the device and the mount, remove any slack in the OBDII cable and coil it behind the side panel you removed earlier. Use the supplied zip ties to secure the coiled cable from moving, falling down under the dash, or interfering with pedal operation. Replace all panels removed during installation.

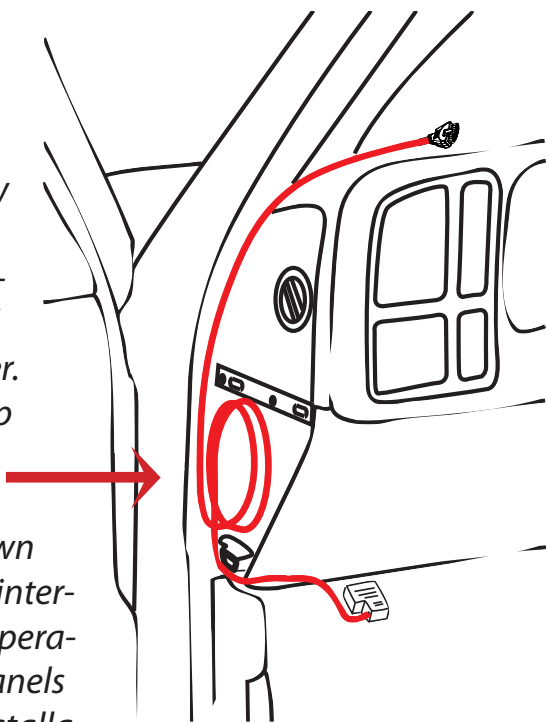

Device Power Up

The CS/CTS device will not power up until the vehicle is started. If you wish to power the device prior to starting the vehicle, turn the key to the run position and press the menu button (CS) or touch the screen (CTS).

CTS/CS Device Descriptions

INTRODUCTION

PARTS DESCRIPTION

INSTALLATION

OPERATING INSTRUCTIONS

INTERNET UPDATES

APPENDIX

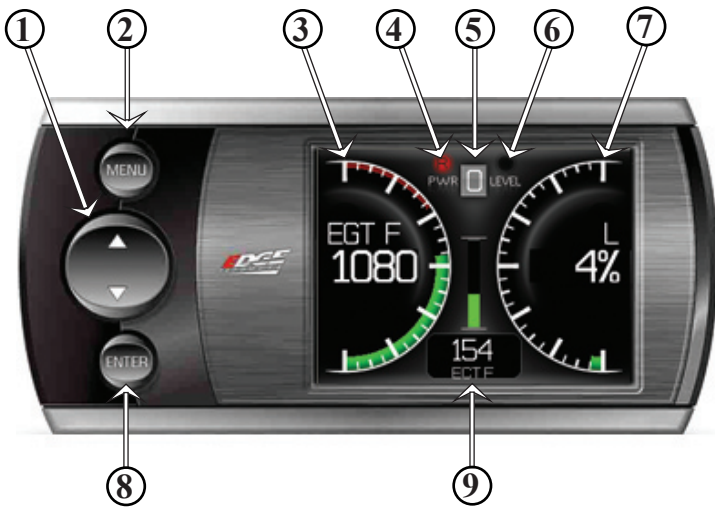
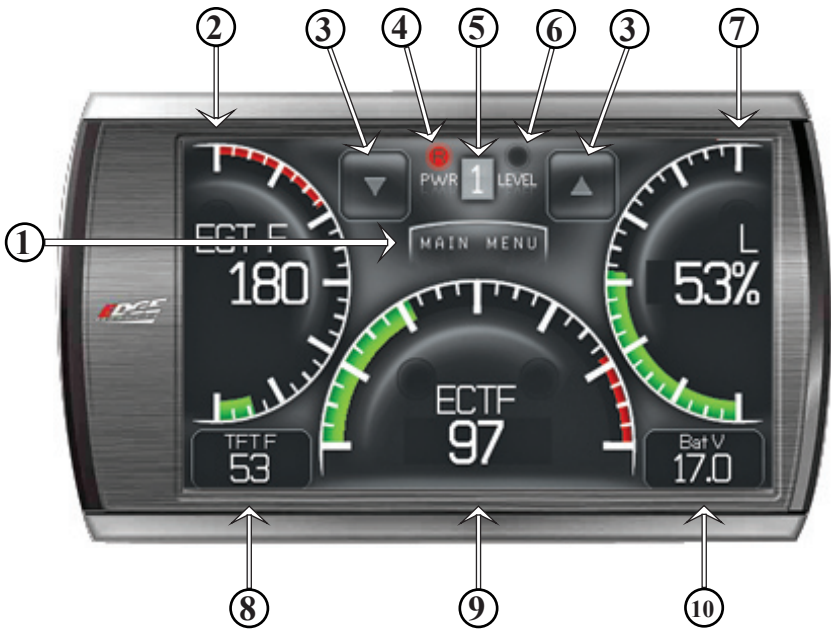

CTS LAYOUT

- 1. Main Menu button** - The main menu button gives you access to the main menu.
- 2. Left Gauge** - The left gauge is one of three analog style gauges. The displayed parameter for all gauges can be changed by simply touching the gauge and choosing a different parameter from the drop down list.
- 3. Power level up/down Arrows** - On the JUICE ATTITUDE these buttons are used to toggle the power level up/down. On the EVOLUTION, INSIGHT and MILEAGE MAX these buttons may be used for future feature enhancements.
- 4. Alert Indicator** - The alert indicator light will illuminate (red) when an alert limit is exceeded. When this light contains an "R," it indicates that your Diesel Particulate Filter (DPF) equipped vehicle is performing a regeneration cycle.
- 5. Power Level Indicator** - The power level indicator represents the current power level. 0 represents stock.
- 6. Backdown Indicator** - (Juice/Attitude only) The backdown indicator light will illuminate (yellow) when the Juice module is decreasing power added by the device while exceeding a backdown limit. The light will contain one of the following characters; E = EGT, S = Transmission Slip, C = Cold Engine.
- 7. Right Gauge** - The right gauge is one of three analog style gauges.
- 8. Lower Left Gauge** - The Lower Left Gauge is one of two digital gauges.
- 9. Center Gauge** - The Center gauge is one of three analog style gauges.
- 10. Lower Right Gauge** - The Lower Right Gauge is the second of two digital gauges.

CS LAYOUT

- 1. Up/Down Arrow Button** - On the JUICE ATTITUDE these buttons are used to toggle the power level up/down. On the EVOLUTION, INSIGHT and MILEAGE MAX these buttons may be used for future feature enhancements. In the menus these buttons are used to select the menu items and increase or decrease values.
- 2. Menu Button** - The menu button gives you access to the main menu.
- 3. Left Gauge** - The left gauge is one of two analog style gauges. The displayed parameter for all gauges can be changed by pressing the enter button, choosing the desired gauge, and selecting a different parameter from the drop down list.
- 4. Alert Indicator** - The alert indicator light will illuminate (red) when an alert limit is exceeded. When this light contains an "R," it indicates that your Diesel Particulate Filter (DPF) equipped vehicle is performing a regeneration cycle.
- 5. Power Level Indicator** - The power level indicator represents the current power level. 0 represents stock.
- 6. Backdown Indicator** - (Juice/Attitude only) The backdown indicator light will illuminate (yellow) when the Juice module is decreasing power added by the device while exceeding a backdown limit. The light will contain one of the following characters; E = EGT, S = Transmission Slip, C = Cold Engine.
- 7. Right Gauge** - The right gauge is one of two analog style gauges.
- 8. Enter Button** - The enter button when pressed from the main screen will allow you to change the gauge parameters. In the menus it allows you to select the highlighted option.
- 9. Center Gauge** - The center gauge is a bar style gauge.

Navigating the Menu System

Main Menu



The main menu consists of 6 options:

- **View camera** - shows camera the camera image.
NOTE: ONLY PRESENT WHEN A CAMERA IS INSTALLED ON A CTS.
- **Show alerts** - shows the current, active alerts and their current set values.
NOTE: THIS MENU ONLY APPEARS WHEN THERE IS AN ALERT ACTIVE.
- **Programming** - allows you to program the vehicle to one of the pre-tuned power levels included with the Mileage Max or Evolution. This is not present on the Juice-Attitude.
- **Diagnostics** - gives you the ability to scan and clear trouble codes, as well as data stream certain key vehicle functions.
- **Options** - gives you access to the Alert Settings, the Screen Layout, and the Brightness menus. All of these menus will allow you to change their related parameters.
- **Help** - is used to display product and vehicle information, as well as Edge Products contact information, and technical support tools.

Menu Navigation Buttons

Both the CS and CTS devices provide you with the following three buttons for navigating the menu system:

Menu: The Menu button allows you to enter the main menu (CS only). Once you are in the main menu you'll use the Menu button to return to the previous screen.

UP/Down Arrow: The Up/Down Arrow button will allow you to toggle up or down through the menu options, you'll notice it highlights each option as you toggle.

Enter: Pressing the enter Button will select the currently highlighted option.

NOTE: WITH THE CTS DEVICE YOU CAN SIMPLY TOUCH THE OPTION YOU'D LIKE TO SELECT ON THE MENU SCREEN. AS A TOUCH SCREEN DEVICE IT WILL AUTOMATICALLY SELECT THE OPTION YOU'VE TOUCHED AND ADVANCE YOU TO THE SELECTED OPTION SCREEN.

WARNING: YOU SHOULD NOT OPERATE THIS DEVICE WHILE DRIVING. PERFORM ALL ADJUSTMENTS OR CHANGES WHILE STOPPED.

The menu items and operating instructions contained in the following several pages are meant to cover a wide variety of vehicles, as such some of the options/features covered in the operating instructions may not apply to your vehicle. Your CS/CTS will display only the options/features that your vehicle's computer system is capable of executing.

View Camera (CTS-Only)

If you have a back up camera or other RCA device connected to the CTS, the view camera menu item will be active. It will not be active if you don't have a device connected.

The view camera menu item will display the back up camera or other RCA jack device you have connected when you select the menu item. Once you've selected View Camera, simply touch the screen to return to the Main Menu.

If the CTS can detect gear position, when the gear selector is placed in reverse the CTS screen will automatically show the camera image.

***WARNING: DO NOT RELY SOLELY ON THE CAMERA IMAGE FOR BACKING UP. IT IS POSSIBLE FOR THE CAMERA IMAGE TO FREEZE. ALWAYS USE YOUR MIRRORS, AND LOOK BEHIND YOU BEFORE BACKING UP. OBJECTS IN THE VIEW MAY BE CLOSER THAN THEY APPEAR. IF YOU ARE USING A CAMERA NOT MANUFACTURED BY EDGE PRODUCTS, THE IMAGE MAY BE REVERSED.**

CS/CTS Alerts

The CS/CTS device is equipped with an alert system that notifies the user when vehicle parameters are outside a user-defined value.



There are several ways CS/CTS alerts are indicated. The first is on the main screen. If you have an alert condition the alert indicator light will illuminate. On the main screen the alerting parameter will flash red and the alert notification will sound. If the alerting parameter is not displayed on the main screen, the following screen will appear.



This Alerts screen will show all parameters for which an alert has been set. If an alert value is outside the user-defined setting, it will flash red. The Alerts screen will stay in view for a minimum of three seconds, until no alert condition exists, or until the screen/menu button is touched, at which point it will return to the main gauge screen.

Show Alerts



If you have exited the Alerts screen (shown on the previous page) you can return to the screen by entering the main menu and selecting the Show Alerts menu.

The Show Alerts Menu item is a dynamic menu item, meaning it only appears under certain conditions. If you aren't currently meeting/exceeding an alert then the Show Alerts menu item will not be displayed in the Main Menu.

PROGRAMMING

**Choose your power level in the Programming menu:**

The CS/CTS device comes ready with power levels to be programmed into your vehicle's Power Control Module (PCM) (see the Power Levels section of the manual for further detailed Power Level descriptions). You can choose these levels by entering the Programming menu, and choosing from one of the listed Power Levels. The available levels will depend on the make and model of your vehicle as well as the product type.

Select the power level that best suits your needs by highlighting it and pressing enter (or simply touching it if you're using a CTS).

Note: Please visit www.edgeproducts.com to see the detailed list of CS/CTS dyno proven power/performance gains by vehicle make/model/year.

POWER LEVELS



The CS/CTS Evolution typically has 4 levels. Each level is tuned specifically for different driving situations. The level names are reflective of what the driving level should be used for. As a general rule of thumb the Economy level has the lowest power output, and the Extreme level has the highest power output. The Performance, and Extreme levels should be used only when you desire a high power output from the vehicle.

NOTE: PERFORMANCE AND EXTREME LEVELS ARE NOT INTENDED FOR, AND SHOULD NOT BE USED FOR TOWING.

TRANS ONLY- The Trans Only level only makes changes to the transmission. It will provide firmer transmission shifts which help increase transmission life.

ECONOMY - The economy level is the lowest power setting. It has been specifically tuned for optimum fuel economy, we recommend using this level for daily driving.

TOWING - The towing level is designed for towing, Tuning strategies are optimized to provide power where it is needed most in order to move a load.

PERFORMANCE - The Performance level is a high power level. The fuel injection and timing strategies are tuned semi aggressively to extract substantial power gains from the vehicle without sacrificing drivability or durability.

EXTREME - This is the highest setting for the Evolution. The fuel injection and timing strategies are aggressively tuned to extract high performance from your vehicle without sacrificing drivability or durability.

Custom Options

After choosing a power level to program into your vehicle you are prompted with the option to "Create a custom program." Choosing YES will load the Custom Options menu.



You may have the option to change certain parameters of the level you choose. To use the standard power level without using the custom options simply choose NO. If you choose yes, the following screen will appear.

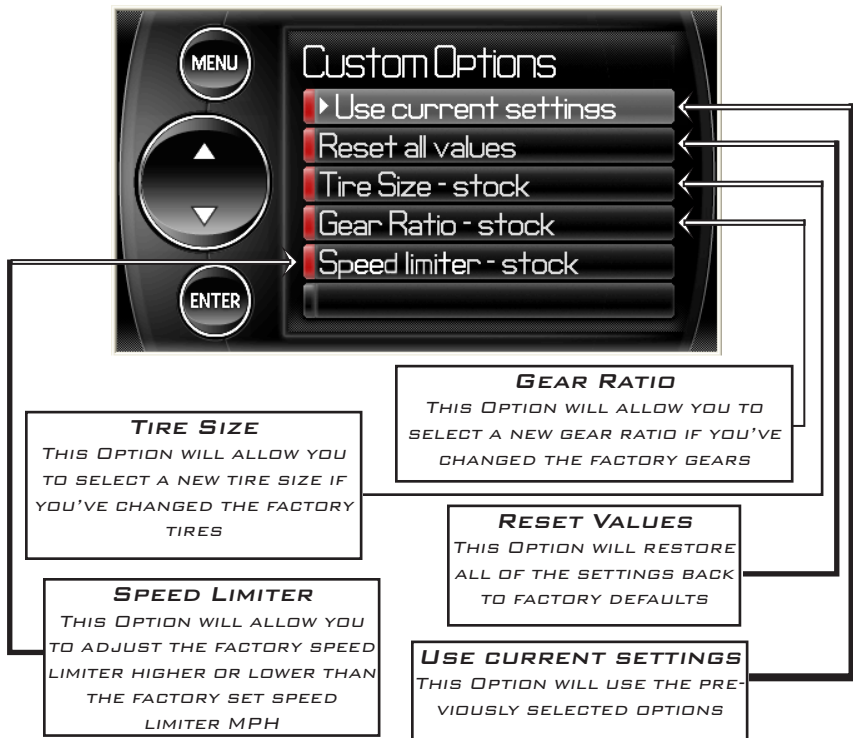

CAUTION!

Your Evolution programmer has the ability to remove/adjust your vehicle's factory speed limiter. Removal/adjustment of the factory speed limiter is intended for use at a closed circuit, legally sanctioned racing environment. Even if racing in a legally sanctioned racing environment, it is your responsibility to ensure your tires and other vehicle components are rated to travel at increased speeds with the speed limiter removed/adjusted. If you remove/adjust the speed limiter during highway driving, it is your responsibility to obey all driving laws, including adhering to posted speed limits. Removing/adjusting the speed limiter for purposes inconsistent with the product's intended function, as stated herein, is a violation of the product's intended use and invalidates the product's warranty. Edge Products is not responsible for, or liable for the consequences of improper product use.

During programming, the CS/CTS device will go through a series of screens telling you the actions it is completing.

The first screen you'll see will show **Creating files**, the second screen will show **Unlocking Module**, the third screen **Writing files**, and the fourth screen **Programming complete**. This process can take several minutes depending on your vehicle **year/make/model**.



After the CS/CTS device has successfully programmed your vehicle, the programmed level number will appear on the main screen in the level indicator box.

Diagnostics

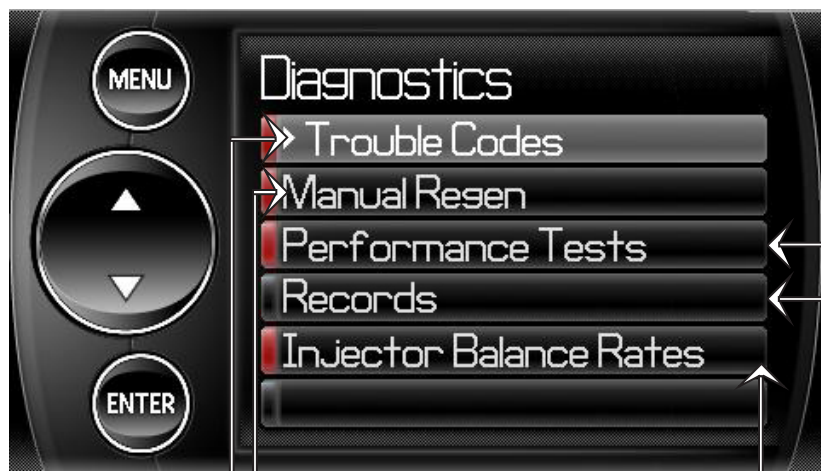

When your PCM detects a problem with your vehicle it sets a trouble code. Use this menu item to retrieve the code, and to clear it after retrieval.

Manual regeneration manually clears out the DPF. This can be helpful prior to heavy towing, racing, or prior to going off road in dead or dry shrubs/grass.

Injector Balance Rates (Diesel trucks only) are used to determine if all the injectors are operating within the correct tolerances. (See Injector Balance Rates section)

Records contain certain parameters for play back. This is useful on the drag strip, at a sled pull, or when you are trying to trouble shoot a problem/bug.

Performance tests can be helpful for measuring performance gains after vehicle modifications have been installed (intake, exhaust programers, etc) - Use this menu to access 0-60 and 1/4 mile tests

Trouble Codes

The diagnostics scanner included with the CS and CTS devices is a powerful tool that allows you to view and clear Diagnostic Trouble Codes (DTCs) on your vehicle. DTCs are the messages your vehicle's computer stores when it detects a problem with your vehicle. The "Check Engine" light on your dash is activated by the presence of most DTCs (some DTCs may not set a check engine light).

Retrieving Codes

If you want to retrieve and view the DTCs on your vehicle, select the **Trouble Codes** from the Diagnostics menu. Make sure the Key is in the on position. Select Trouble Codes from the Diagnostics menu and Read DTCs from the following menu.

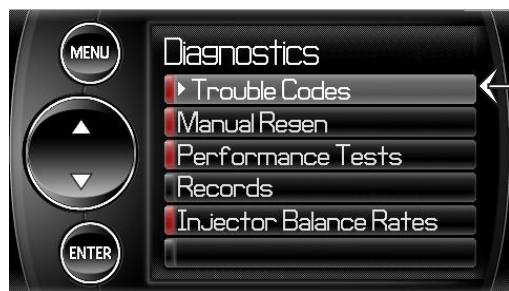

Clearing Codes

After you've retrieved the trouble codes and recorded them, you can clear the trouble codes by selecting Clear DTCs from the menu. This will erase any of the codes currently set. If the codes come back we recommend you see a qualified mechanic who can accurately diagnose/repair the problem.



DPF Regeneration

If you own a diesel powered vehicle built after January 1st 2007, your vehicle is equipped with a diesel particulate filter (DPF). This filter is used in conjunction with a diesel oxidation catalyst. Together they work to reduce the amount of soot and emissions emitted from the tailpipe. As soot builds up in the DPF it will begin restricting the filter. The soot that gathers is automatically purged in one of two ways: Passive Regeneration & Active Regeneration. Both methods occur automatically and require no action on your part. During either of these regeneration methods, you may notice an increase or change in the exhaust noise & increased EGT.

Passive Regeneration

Passive regeneration occurs when the exhaust temperature (EGT) reaches an appropriate level in order to oxidize or burn soot to clean the DPF. This method can happen as a result of normal engine operating conditions, typically when the engine reaches an EGT high enough to burn off the soot (i.e. heavy towing, high load conditions etc.) If EGTs do not get hot enough to cause passive regeneration, then your truck's engine-control system automatically initiates an active regeneration.

Active Regeneration

During active regeneration, the truck computer cleans the DPF by raising the exhaust temperature to a point where the soot is burned away. This is accomplished through various engine actions which raise the EGTs in the oxidation catalyst/DPF system to a level where the soot is burned off. After the soot is burned off, the EGTs and back-pressure (restriction) fall back to normal levels. In order to help you know the status of DPF Regeneration, the device will display an "R" circled in red in the middle top section of the screen anytime active regeneration is happening. This indicates whether the alert is on or off.

Manual DPF Regeneration

Completing a manual regeneration cycle will clear the soot mass in the filter, and lower exhaust back pressure/free up exhaust flow. It will be helpful to do this before any competition such as drag racing or tractor pulling. It's also helpful to use if you're going to be in a situation where you don't want the truck computer to initiate the Active Regeneration cycle on it's own, (i.e. heavy towing, or driving where dry grass, shrubs, or other combustibles are present). You can do this by selecting the **Manual Regen** option on the Diagnostics menu.



When manually initiating a regeneration cycle some vehicles will require a drive cycle (i.e. you have to drive the vehicle some distance) while others may allow you to initiate a **Service Regeneration** where you can leave the vehicle parked and engine running. If the latter is the case, be sure to follow the guidelines below:

NOTE: EXHAUST TEMPERATURES MAY BE GREATER THAN 300 C (572 F) DURING SERVICE REGENERATION.

To prevent injury or property damage do the following:

1. PARK THE VEHICLE OUTDOORS AND KEEP PEOPLE, OTHER VEHICLES, AND COMBUSTIBLE MATERIAL AWAY FROM IT.
2. DO NOT LEAVE THE VEHICLE UNATTENDED.
3. DO NOT CONNECT ANY SHOP EXHAUST HOSES OR VENTS TO THE TAIL PIPE.

Due to the elevated ending temperatures during this procedure open the hood and keep the front of the vehicle away from anything impeding air flow to the radiator.

Performance Tests



The CTS and CS devices allow you to test the performance of your vehicle by timing 0-60 and quarter mile runs.

The results recorded by the Performance Test features will likely differ from what you'll see on a drag-strip or other racing venues. Incorrect speedometer calibration, data sample rate, and tire slippage can cause miscalculations in the displayed results. Use this feature for entertainment purposes only. **THIS FEATURE IS NOT TO BE USED TO BREAK ANY LOCAL/STATE/FEDERAL TRAFFIC LAWS.**

Select the 0-60 menu item and the following screen will appear



After bringing the vehicle to a stop, follow the directions noted on the screen.

0-60 Test

The 0-60 test will require you to come to a stop and will start timing the run as soon as you start accelerating

1/4 Mile Test

The quarter mile test will simulate a drag strip light tree, and start timing the run once the green light is lit.

The Quarter mile test will prompt you with a drag strip style light tree. If you watch the circles on the left they will light up yellow, then green. If you go before green appears then a red light will light up in the bottom showing that you started too early. If you don't start early then you will see a green light remain in the bottom circle.

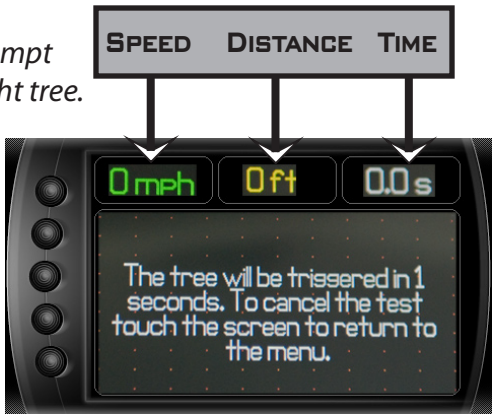

When you've finished the quarter mile run the device will display the ending mph, the distance traveled in ft., and the elapsed time it took to reach 1/4 mile. In addition it will graph your MPH vs Speed so you can better analyze the run.



Injector Balance Rates

*ONLY AVAILABLE ON CERTAIN MODELS.

If you experience a misfire, knock, excessive smoke, or rough running condition with no electrical DTCs, the Injector Balance Rate option can help identify faulty injectors.

The balance rates are the fuel adjustments for each individual cylinder based on the variations in engine crankshaft speed. The balance rates will change depending on if the transmission is in Neutral or Drive. Monitor and record all cylinder balance rates in drive and neutral. Injectors that read a higher numerical value than ± 4.0 (e.g. $\pm 5,6,7$ etc.) in park/neutral and ± 6.0 in drive may identify faulty injectors.

If the balance rates show a possible faulty injector, we recommend you consult a professional diesel mechanic who can verify this test and also perform a Cylinder Power Balance test to diagnose faulty injectors.

After Selecting Injector Balance Rates from the Diagnostics screen, you'll be prompted by the following screen

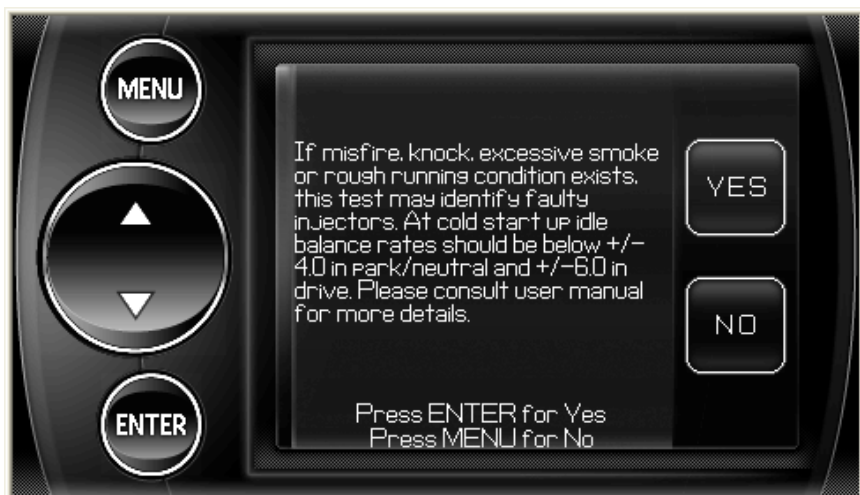

After selecting yes, you'll see a screen with 8 parameter data display boxes. Each box represents an Injector. This screen is where you'll want to compare the injector balance rates in both Park and Drive.

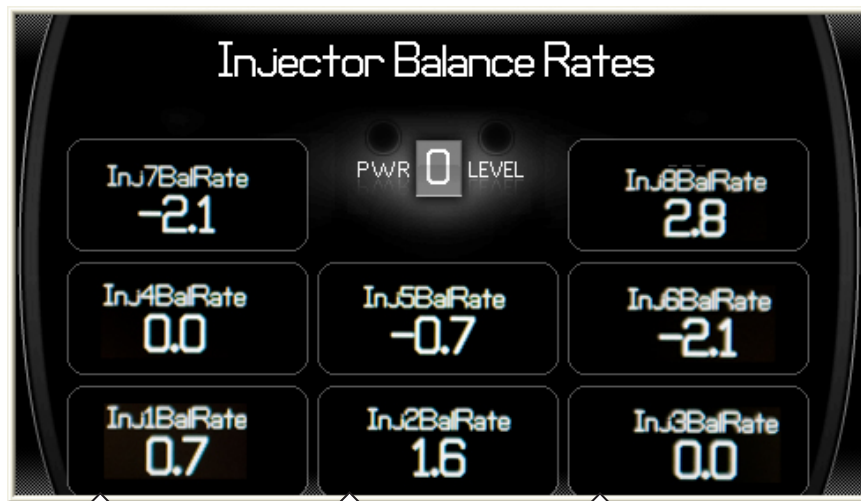

In Park the values should not have a numerical value higher than + or - 4.0, in Drive they should not be higher than + or - 6.0

Note: The above injector balance screen shot represents a truck with injector balance rates that are acceptable. The sample was taken in park. You can see that there are no numbers higher than +4.0 or -4.0 on the screen, so it's safe to assume the injectors are working properly.

Options



The Options menu contains menu items that will let you customize the device settings to your liking, as well as change the alert default settings to best fit your needs.

Alert Settings

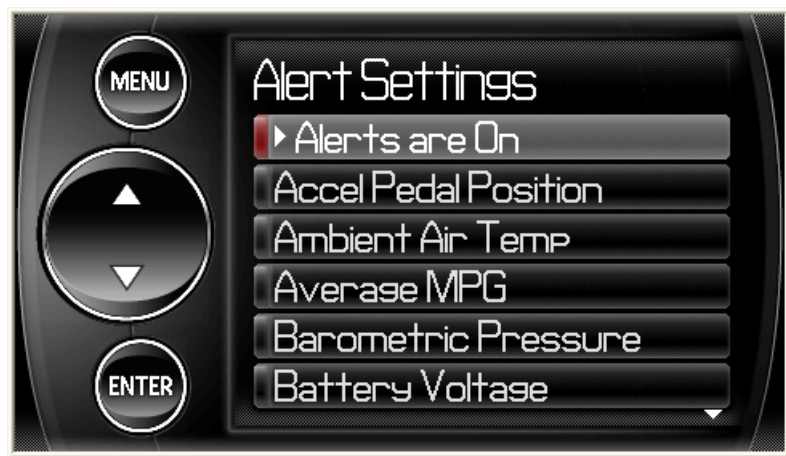

The Alert Settings screen allows you to turn the alerts on/off both collectively and individually, and also lets you set the alert values for each of the parameters.

To turn alerts on, select the top screen option **Alerts are Off** and press enter. You'll see the option change from Off to On or vice versa.

To individually disable/enable an alert, or to change the alert value, simply scroll to the parameter you'd like to change, select the parameter and the following screen will appear

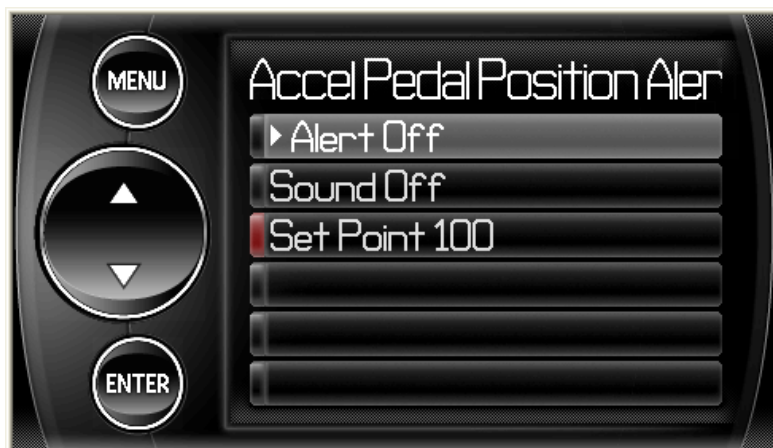

On the screen you have the option to turn the parameter off/on, turn the sound off/on and change the set point data.

Turning the Alert off will completely disable the alert visually as well as audibly.

If you turn just the sound off, you'll still receive a visual alert when the set-point is reached.

You can change the set point to better fit your driving style or individual needs, the default settings are Edge Products recommended alert settings.

Sound Duration

You can adjust the duration of the alert sound by using this menu option. Simply press the up/down arrow until you have the desired sound length in seconds.



Screen Layout

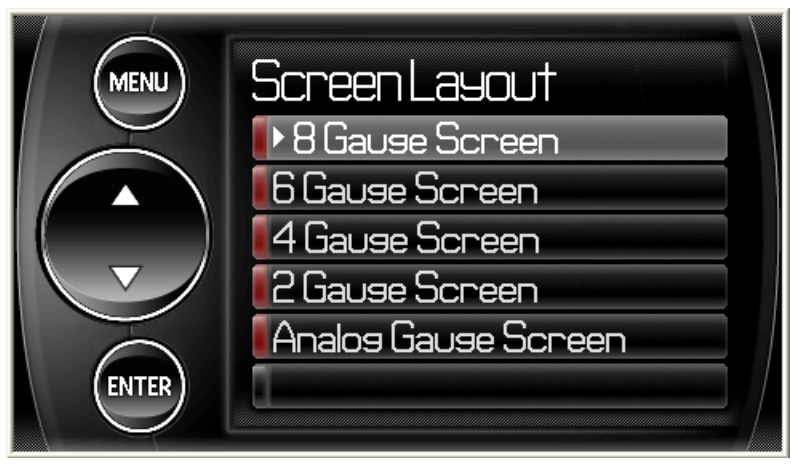

The screen Layout menu allows you to choose from five different screen layout options. The Analog Gauge Screen is set as the default. Once you've selected the gauge screen you want to use you can customize which parameters are displayed by simply touching the parameter value on the main screen (CTS) or pressing enter while on the main screen (CS) and choosing the PID you'd like to display from the drop down list.

Backlight Auto Dim



The CS and CTS devices both have ambient light sensors. As it gets darker outside the device will automatically dim the screen for easier viewing. The Auto Dim feature allows you to set how far it will dim the screen.

***NOTE - IT'S BEST TO MAKE THIS ADJUSTMENT AT NIGHT SO YOU CAN VERIFY THE SCREEN BRIGHTNESS IS TO YOUR LIKING. YOU'LL NEED TO RETURN TO THE MAIN DISPLAY SCREEN AFTER SETTING THE AUTODIM PERCENT IN ORDER TO SEE THE CHANGES.**

Menu Time-out



The CS and CTS devices have a built in time-out feature. The purpose of this time-out is to prevent the unit from staying powered up for excess amounts of time. If you leave the device in a menu option and then exit the vehicle, the device will stay powered up for 300 seconds by default, after which it will return to the main menu and then power off. If left in a menu while the truck is running or the key is on it will return to the main menu after 300 seconds. You can adjust the wait time to be longer or shorter by simply using the arrows to take the time up/down.

**NOTE: THIS FUNCTION ONLY APPLIES TO MENU SCREENS. IF YOU ARE VIEWING A PARAMETER ADJUSTMENT SCREEN LIKE THE ONE PICTURED ABOVE, THE DEVICE WILL NOT TIME OUT. IF YOU DO NOT EXIT THESE SCREENS, THE DEVICE WILL NOT POWER OFF AND MAY DISCHARGE THE VEHICLE'S BATTERY.*

Tire Size

**ONLY AVAILABLE ON CERTAIN MODELS.*

The CS/CTS Evolutions will allow you to re-calibrate the speedometer for non-stock tire size. To do so select Tire Size in the Options Menu.

Once you've selected the Tire Size menu, you'll see the following options:

English = **35/12.50/16** where 35 is the height, 12.50 the width, and 16 the wheel size

P-Metric = **275/75/16** where 275 is width, 75 is aspect ratio, and 16 is diameter

Circumference = The outer circumference of the tire on your vehicle

Height = The Height of the tire on your vehicle

Choose the method for inputting tire size that best fits your needs. If your tire size is printed on the tire in P-Metric the easiest option will be choosing P-Metric (shown below).

After selecting the method, you'll see the following screen



Use the key pad on the right hand side of the screen to enter the tire size that is currently on your vehicle. You can navigate through the numbers with the UP/Down arrows, or by touching the numbers (if you have a CTS). Once you've entered the value hit enter and the Custom Tire size you've entered will be saved.

Changing the tire size on the screen will not automatically re-calibrate the vehicle computer for tire size, you must program the vehicle in order for the changes to take place. Once you've set the tire size it will be saved, and when you program a power level to the truck the tire size will be programmed into the factory computer and re-calibrate the speedometer.

After you've saved the tire size in this menu, you will not need to re-enter it in custom options, it will be saved and every time you program the vehicle it will program in the saved tire size data.

Factory Reset



If you would like to revert back to the factory default settings, simply select Factory Reset and choose YES on the screen above.

Many of the settings will be returned back to the defaults as they were when the unit was new. Any changes you've made to the alerts, the gauge screen displays, etc will be returned to the defaults set by Edge Products.

NOTE: FACTORY RESET WILL NOT RETURN THE VEHICLE TO STOCK FROM A PROGRAMMED POWER LEVEL.

Camera Delay (CTS ONLY)



The Camera Delay menu item is always displayed. If you don't have a camera or other RCA device connected, this menu option will not affect device functionality in any way.

The CTS is designed to automatically engage the back-up camera when the vehicle gear selector is in Reverse (may not function on all vehicle models). The camera delay will allow you to customize the delay time for the device to switch from the main viewing screen to camera view. If this is set too short then you'll see the device blink as you move the gear selector past Reverse. If it's set too long the screen may not appear before you start backing up. Some vehicles will communicate gear position faster than others, so this menu option allows you to customize the delay to your liking.

Help Menu



The Help menu contains useful information about your device, and the vehicle it is being used on. It also contains Edge Products Contact Information, and Technical Support tools.

Product Info

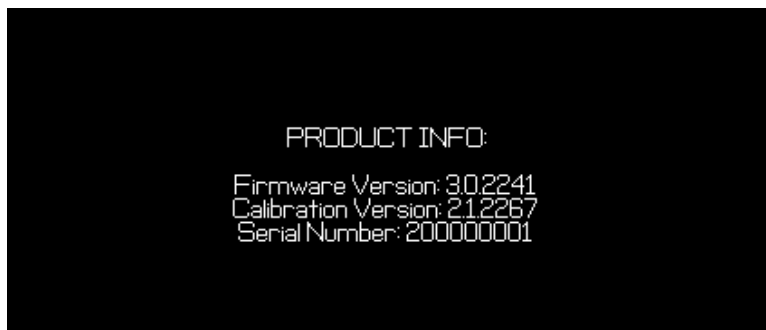

The Product Info screen contains three important items.

Device Firmware Version

Device Calibration Version

Device Serial Number

The Firmware is the software that runs the device functions, I.E. menu systems, programming routines etc.

The Calibration is the data that the device programs into your vehicle in order to achieve better performance/mileage.

From time to time Edge Products will release updates with improved functionality for both Firmware and Calibrations. Each of these updates are labeled with a number, the number shown in this menu represents the version that is currently on your device.

The Serial Number is a number assigned to your particular device. This number is used to identify your device in the software update process and to Edge Technical Support.

Vehicle Info

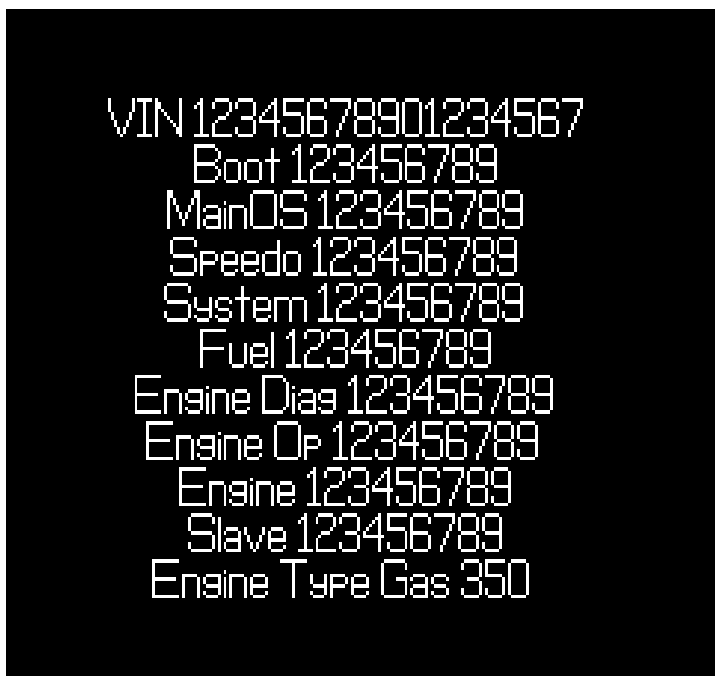

Vehicle Info contains important information about your vehicle. This information will help Edge Products Technical Support by letting them know all of the specifics of your vehicle, and the programming that is currently loaded on your vehicle's PCM (vehicle information may differ from above screen).

Contact Info



The Contact Information menu contains the Edge Products web site URL, the company address, the Technical Support email address, and the Technical Support phone number.

This information will be useful if you need to contact Edge Products for warranty claims, sales information, upgrade information or any other technical questions/inquiries.

CONTACT INFO

Website <http://www.edgeproducts.com>

Address Edge Products
1080 South Depot Drive
Ogden, UT 84404

Tech Support Email tech@edgeproducts.com
Tech Support Phone 888-360-3343

Tech Support Tools



The Technical Support Tools menu contains tools made specifically to help Edge Products Technical Support representatives help customers when they are experiencing problems with their vehicle or device. This menu should only be used when requested by Edge Products Technical Support personnel.

The tools contained in this menu are locked and will not function without specific numbers provided by Edge Products Technical Support.



Fusion Update Software

REQUIRES INTERNET CONNECTION

Fusion Software allows the user to update their device to the latest version of firmware and calibration files. This software is included on the disc provided with your device. It can also be downloaded for free from Edge Products web site at www.edgeproducts.com, or the CD can be requested by calling 888-360-EDGE (3343).

Note: Be sure to install both the SOFTWARE and the DRIVERS that come included in the download or on the disk before you connect your device to your PC. During the installation you will be prompted to install the drivers, choose yes.

For step by step installation instructions please copy this link into your web browser http://www.edgeproducts.com/product_images/product_update-file-11.pdf

Once you've installed Fusion, click on the Fusion icon on your PC desktop. You may be prompted for a Fusion login. If you have not yet created an account, click on "Create a New User" and you will be directed to a webpage to create your login information. After entering your information, a password will be sent to the email address you provide. Be sure your email account doesn't block emails from "edgeproducts.com". Upon receiving the password, enter your email address and password on the login screen.

You'll be prompted to connect the device to launch. After connect-ing the device, you'll see the following screen, click yes to continue with the update.

NOTE: Be sure to return your vehicle to stock before connecting the device to Fusion.

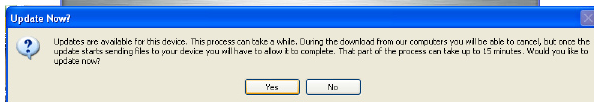

NOTE: If the USB connector you received has 2 plugs, it is recommended that you plug both USB connectors into the computer before connecting the device to the other end to ensure proper operation.

After you've selected yes on the previous screen the Fusion software will go through the steps in order to update the device. Once it's completed you'll see the following screen

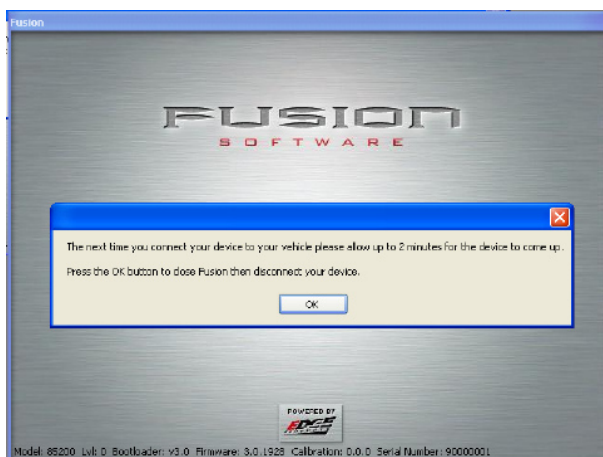

Click OK and the update will be completed. You'll now have the latest Firmware, and Calibration on your device.

Model: 35060 Lvl: 0 Bootloader: v2.73 Firmware: 2.50.5434 Calibration: 1.3.5526 Serial Number: 1046832

When your device is connected to Fusion, the device model, Lvl, Bootloader, Firmware, Calibration and Serial Number are all displayed at the bottom of the screen. These numbers will be useful to quickly view the state of your device, and whether or not it is currently programmed to a vehicle.

- **MODEL** : The model number for your device
- **LVL** : The currently programmed level
- **BOOTLOADER** : The bootloader version currently on your device
- **FIRMWARE** : The firmware version currently on your device
- **CALIBRATION**: The calibration version currently on your device
- **SERIAL NUMBER** : The serial number assigned to your device

Possible Programming Errors

Update Required

Fusion is designed to help the development team at Edge Products support new vehicle calibrations.

When you connect your device to the vehicle, the first step it takes is identifying your vehicle's stock file. If the stock file isn't currently supported the device will display a screen alerting you that the stock file is not yet supported, and prompt you to press a button/touch the screen in order to read and save the stock file. Once the device has saved the stock calibration, it will prompt you to connect the device to Fusion. Fusion will ask you if you want to upload your vehicle's stock files to our server. Choosing yes will upload the files to the server, and alert the development team. This will help the development team at Edge Products provide support for your vehicle's calibration as quickly as possible.

Non-Stock condition

During programming, the device will read the stock file on your vehicle and compare it to a corresponding stock file that has been verified by Edge Products. If there is a mismatch the device will alert you, and display this message:

" Non-stock condition detected. This is most likely because your vehicle has been programmed with a competitive product. It is recommended that you return your vehicle to a stock condition with the product that changed it. Alternatively, you can plug your device into the internet update system and it will load the necessary files onto your device to return your vehicle to stock."

If you don't have the competitive product that programmed your truck, connect the device to Fusion where you'll be prompted to download the correct stock files. Once downloaded, simply connect the device to your vehicle, and the device will program the verified stock files to your vehicle.

Accessories

The CTS and CS devices are equipped with an expandable accessories port which interfaces with the Edge Accessory System (EAS), as well as a video-in jack.

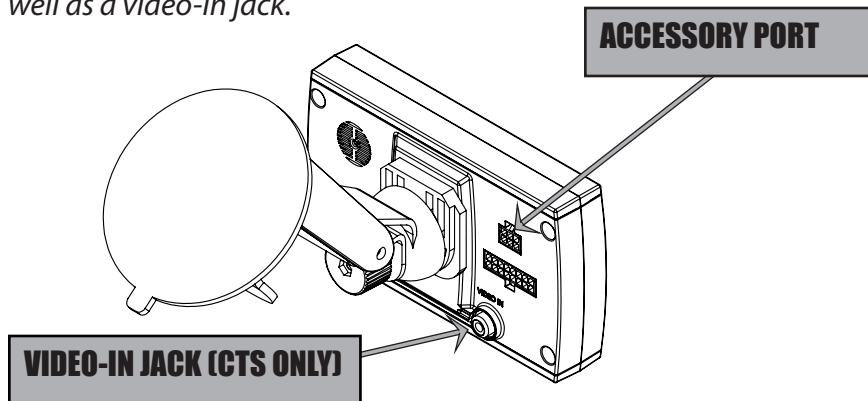

Edge Accessories System (EAS)

The EAS is an accessory network cable that transmits data between the CS or CTS and Edge Accessories.

With the EAS you can add multiple accessories to the CS or CTS using a daisy-chain-style connection system. An example of an EAS accessory is an EGT sensor (shown above right). The EAS allows you to expand and grow your product in the future.

EAS EGT Probe

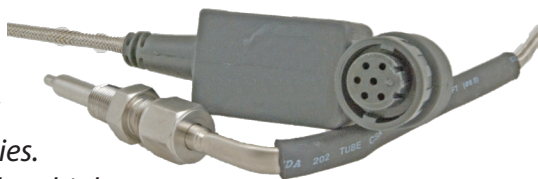

Standard EGT Probe



If you're not interested in an expandable system, use the standard Edge EGT probe (shown left). The standard EGT probe is not expandable with future accessories.

TO VIEW OR PURCHASE EDGE ACCESSORIES VISIT WWW.EDGEPRODUCTS.COM OR CONTACT YOUR LOCAL EDGE PRODUCTS AUTHORIZED MVP DEALER

OEM EGT Locations

**THIS SECTION REFERS TO DIESEL VEHICLES*

The 2007.5 and newer light-duty diesel pickups are equipped with OEM Exhaust Gas Temperature (EGT) sensors, all of which can be monitored with the CS and CTS Devices.

Before a customer uses the vehicle's OEM sensors for reading exhaust gas temperature, it's extremely important that he/she become educated about EGT sensor placement, and understand what exactly to look for when using an EGT sensor on a diesel-powered vehicle.

Edge Products was the first company to integrate gauge screens with their power modules giving customers the ability to monitor EGTs and other vehicle parameters in real-time. Since the introduction of the Attitude monitor Edge Products has taken a strong stance on EGT probe placement. Edge Products has always recommended that the EGT probe be placed in the exhaust manifold, in a pre-turbo location simply because the manifold location gives the best representation of combustion chamber temperatures. Other locations downstream in the exhaust system do not accurately represent combustion chamber temperatures.

The 2008 and newer Ford Powerstroke 6.4L is factory-equipped with an EGT sensor in the pipe prior to the high pressure turbo. This EGT sensor accurately represents EGT temperatures in the combustion chamber.

The 2007.5 and newer GM Duramax, and Dodge Ram 6.7 Cummins do not have EGT sensors placed pre-turbo where the optimum readings can be achieved. When items such as turbos, catalysts, NOX filters, and particulate traps are introduced, temperatures can vary in large margins due to the thermal energy stored/transferred by these devices. This creates an environment that doesn't represent

combustion-chamber temperatures as effectively as a manifold/pre-turbo placed sensor.

Edge Products recommends using a pre-turbo EGT sensor if you use the CS/CTS for any kind of competition, or heavy hauling. If your vehicle is not equipped with a pre-turbo EGT sensor, Edge recommends you purchase an Edge Products sensor and install it in a pre-turbo location.

As noted in the accessories section, you can purchase an Edge Products EGT sensor to be coupled with the Edge Accessories System (EAS) or you can purchase a standalone Edge EGT sensor. Either of these items can be purchased at **www.edgeproducts.com or at your local Edge Products Authorized MVP Dealer.**

If you are unsure whether or not your vehicle is equipped with a pre-turbo EGT sensor please see the diagram on the following page.

If you are unsure how hot is acceptable on your EGT's we recommend you do the following:

- 1 - Display EGTs on your main display screen
- 2- Observe what the EGTs are in your vehicle while it is at a stock power level and accelerating at a heavy load, i.e. pulling a heavy trailer up a long hill.
- 3- Add 100 degrees F to the highest stock reading you've seen and use that number as your max safe EGT.
- 4 - Record these readings for later reference.

The Illustrations on the right represent the 2007.5-2009 light-duty diesel pickups.

The exhaust systems are outlined in order to illustrate where the EGT sensors are placed, and what items exist that may alter temperature as seen at the exhaust manifold.

The **Dodge 6.7 Cummins** is not equipped with a pre-turbo EGT probe. It is however equipped with three EGT probes downstream from the turbo. All of these probe's readings are available for display on the CS and CTS. However they are not an accurate representation of combustion chamber temperatures.



The **GM LMM Duramax** is not equipped with a pre-turbo EGT probe. It is however equipped with two EGT probes downstream from the turbo. Both of these probe's readings are available for display on the CS and CTS. However they are not an accurate representation of combustion chamber temperatures.



The **Ford 6.4 Powerstroke** has an EGT probe placed in the passenger side up pipe prior to the turbo. This is an excellent location for an EGT sensor. The readings you'll see here better represent the temperatures in the combustion chamber than the temperatures you would see down stream.



Modern Light-Duty diesel truck exhaust illustrations

INTRODUCTION

PARTS DESCRIPTION

INSTALLATION

OPERATING INSTRUCTIONS

INTERNET UPDATES

APPENDIX

**DODGE 6.7
CUMMINS**

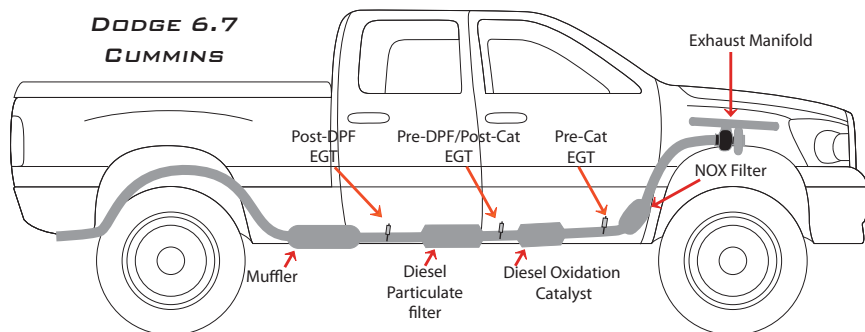

**GM LMM
DURAMAX**

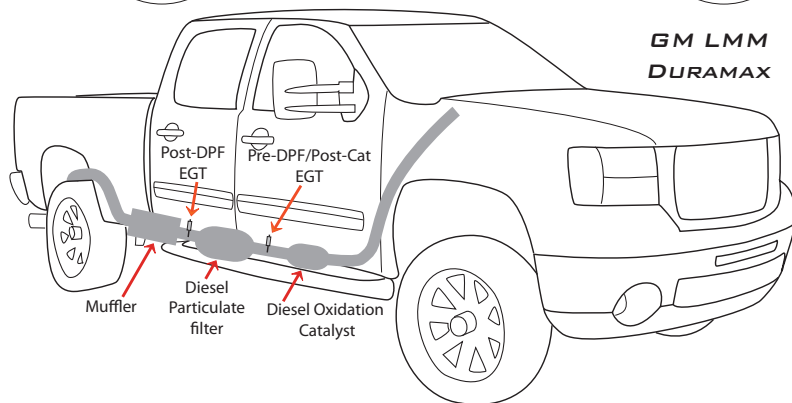

**FORD 6.4
POWERSTROKE**

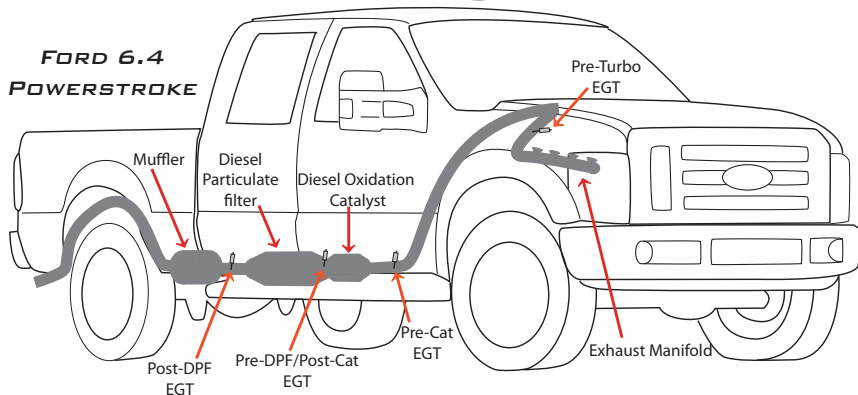

Edge Backup Camera

Finish your CTS off with the Edge Products Backup Camera. The Edge Products Backup Camera provides a high-quality color image with "Night Vision" infrared LEDs allowing users to see objects in total darkness, up to a range of approximately 30 feet. The camera comes with a built-in, theft-resistant mount that installs easily using the license plate mounting screws/bolts. The custom Edge-designed, theft-resistant mount is sturdy and stylish. The quick-release mount features a simple lock-and-key mechanism. The camera is also equipped with a magnetic back allowing users to mount the camera in different locations. The adjustable mounting bracket allows the user to adjust the viewing angle up and down to reach the desired viewing angle.

The CTS will work with most off-the-shelf back-up cameras that use a RCA style video connector. In addition to using the CTS as a back-up camera display device, you can also use it as a display for a DVD player, or other devices equipped with RCA video-out.



TO VIEW OR PURCHASE THE
EDGE BACK-UP CAMERA VISIT
WWW.EDGEPRODUCTS.COM OR CONTACT YOUR
LOCAL **EDGE PRODUCTS AUTHORIZED MVP
DEALER**

Edge Mounting Solutions

Edge Products offers the best custom mounting options on the market. Edge Products pillar mounts or dash mounts offer a unique solution for CS or CTS owners that are looking to add a factory-finish look to their truck. The pods are durable, made from high-quality plastic, and manufactured for a perfect fit and finish. They are angled for easy viewing, can be painted to match vehicle interior color (if needed), and are easy to install. The CS and CTS devices will fit in all Edge Products pods. The CTS will require an adaptor.



TO VIEW OR PURCHASE THE EDGE MOUNTING POD DESIGNED FOR YOUR SPECIFIC VEHICLE, VISIT WWW.EDGEPRODUCTS.COM OR CONTACT YOUR LOCAL EDGE PRODUCTS AUTHORIZED MVP DEALER

Trouble Shooting/Tips

Tip: Programming your vehicle may expose existing defects in your vehicle's PCM that could disable your vehicle. It is advised that you do not program your vehicle in remote locations in case of failure.

Tip: Keep in mind that the CTS/CS is a high performance product and that not all vehicles deliver the exact same power output when programmed with the CTS/CS. It is recommended that you select a program that will best fit your needs. Whether towing, or traveling long distances at high speeds, choose your power level wisely and keep in mind the condition and tolerances of your vehicle when selecting a suitable power level.

Tip: Register your product at www.edgeproducts.com. Registering your product allows us to know exactly which product you have and provide important product updates to you that improve the quality and/or safety of the product. Registering also provides a record in case of product loss, theft, or required warranty work. When you call us for support our team will already have much of the information they need to help you.

TROUBLE SHOOTING GUIDE

SYMPTOM	POSSIBLE CAUSE	SOLUTION
Screen beeps for two seconds (long beep)	The unit is too hot from being in the direct sunlight	Once the device cools down the screen will turn itself on
No display when the key is in "on" position	The unit will not wake up with the key in the "on" position until the screen is touched or any button is pressed	Touch the screen or start the vehicle, if this does not turn the screen on then you will need to call technical support
Vehicle does not start after programming	The calibration may have not written correctly	Select "Return to stock" from the programming menu and try to start the vehicle again. If the problem continues contact technical support
Fusion drivers will not install correctly	The drivers were not successfully installed by the automatic installer	Manually install the drivers, Edge technical support can provide you with instruction on how to do this
Camera picture is frozen	Bad connections	Cycle the key off and on.
Error 16 when programming	There was a communication error	Try to program the level again
Screen beeps quickly	Possible device malfunction	Update the device using the fusion software
Edge EGTs are not displaying	Connector on the back of the device is not fully seated	Make sure the cable connection is not upside down, and push the cable until it is fully seated

Commonly Used Acronyms

ACT = Air Charge Temp	KOER = Key On Engine Running
ACV = Air Control Sensor	KS = Knock Sensor
AOD = Automatic Overdrive Transmission	LOAD = Engine Load
APP = Accelerator Pedal Position	LOS = Limited Operation Strategy
AXOD = Automatic Overdrive Transmission	LPD = Line Pressure Desired
BAT = Battery Voltage	LUS = Lock-up Solenoid
BCM = Body Control Module	MAF = Mass Airflow
BOO = Brake On/Off Switch	MAFV = Mass Airflow Sensor Voltage
BP = Barometric Pressure Sensor	MAP = Manifold Absolute Pressure
CCD = Computer Controlled Dwell	MAT = Manifold Air Temp
CCO = Converter Clutch Override	MCU = Microprocessor Control Unit
CDR = Crankcase Depression Regulator	MIL = Malfunction Indicator Light
CEL = Check Engine Light	MPH = Miles Per Hour
CFI = Central Fuel Injection	OHC = Over Head Camshaft
CHT = Cylinder Head Temperature	OSS = Output Shaft Speed
CID = Cylinder Identification Sensor	PCM = Powertrain Control Module
CKP = Crank Position Sensor	PFE = Pressure Feedback EGR Sensor
CMP = Cam Position Sensor	PIP = Profile Ignition Pickup
CPS = Crankshaft Position Sensor	PSPS = Power Steering Pressure Switch
CS = Color Screen	RPM = Revolutions Per Minute
CTS = Color Touch Screen	SES = Service Engine Soon
DPF = Diesel Particulate Filter	SIL = Shift Indicator Light
DTC = Diagnostic Trouble Codes	SPARK = Spark Advance/Retard
ECA = Electronic Control Assembly	SPOUT = Spark Output Signal (from ECA)
ECM = Electronic Control Module	STAR = Self Test Automatic Readout
ECT = Engine Coolant Temp	TAPS = Throttle Angle Position Sensor
EDF = Electric Drive Fan Relay	TCM = Transmission Control Module
EDIS = Electronic Distributor	TFI = Thick Film Ignition System
EGO = Exhaust Gas Oxygen Sensor	TFT = Transmission Fluid Temperature
EGR = Exhaust Gas Recirculation	TGS = Top Gear Switch
EGRC = EGR Control Solenoid	THS = Transmission Temperature Switch
EOT = Engine Oil Temperature	TPS = Throttle Position Sensor
EVP = EGR Position Sensor	TQC = Torque Control
EVR = EGR Valve Regulator	TSS = Turbine Shaft Speed
FDM = Fuel Delivery Module	TTS = Transmission Temperature Switch
FPM = Fuel Pump Monitor	VAF = Vane Air Flow Sensor
FRP = Fuel Rail Pressure	VAT = Vane Air Temperature
HEGO = Heated Exhaust Gas Sensor	VCT = Variable Cam Timing
IAT = Intake Air Temperature	VSS = Vehicle Speed Sensor
ICM = Integrated Controller Module	WAC = WOT A/C Cut-off Switch
IDM = Ignition Driver Module	WOT = Wide Open Throttle
ISC = Idle Speed Control	
ITS = Idle Tracking Switch	
IVS = Idle Validation Switch (Diesel)	
KAM = Keep Alive Memory	
KOEO = Key On Engine Off	